

POLE ACCESSORIES

MODEL: E16376

- 4" 90° Twin Square Horizontal Tenon
- Conforms to ASTM-A-500 Grade B: Minimum Yield Strength of 46,000 PSI
- Powder Coated Finish on Sandblasted Surface Chemical Treated to ensure Maximum Paint Adhesion.
- Baked at 400°C to ensure Maximum Hardness and Durability.



Dimensions

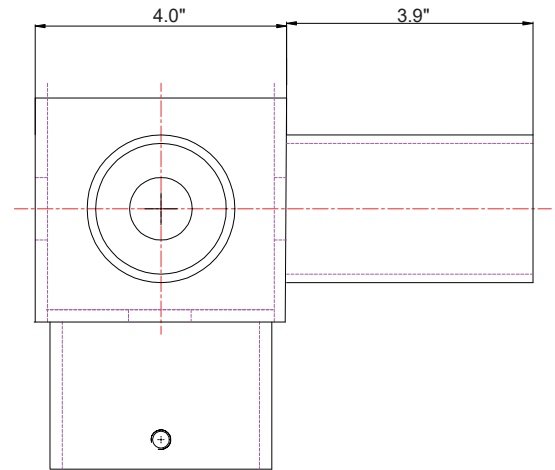
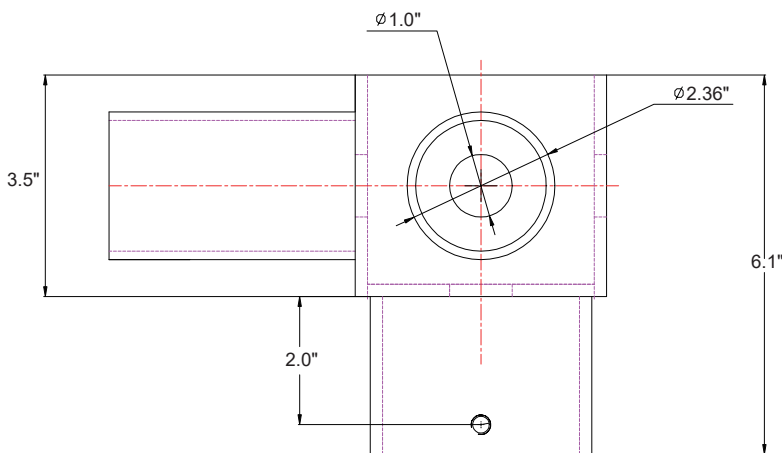

WF Harris Lighting, Inc.

Innovative Lighting Designs Since 1970

4015 Airport Ext. Road • Monroe, NC 28110 USA
704.283.7477 (Headquarters) • 800.842.9345 (Toll Free)

E-Mail: customerservice@wfharris.com

www.wfharrislighting.com