

INDOOR TROFFER

TROFFER: E122T

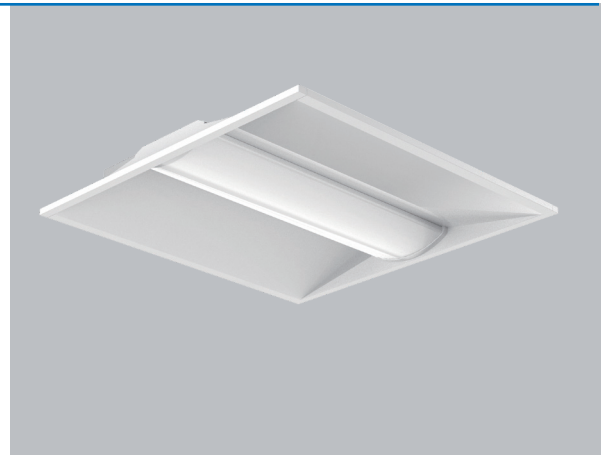

- With PC lens, never turn yellowing. Uniformity light, low glare with high reliability.
- Multi-sizes, multi-lumen packages. Meet your various requests.
- Easy plug in sensor, NLC 5.0 Listed, PIR/Microwave/Bluetooth Sensor optional.
- Ultra slim design, only 50mm height, enlarging your loading qty and reduce shipping cost.
- Factory or Field Install EB available, 90 mins backup time, Integrated test button, easy installation.
- EB Field Installed Parts are Special Order.



Dimensions

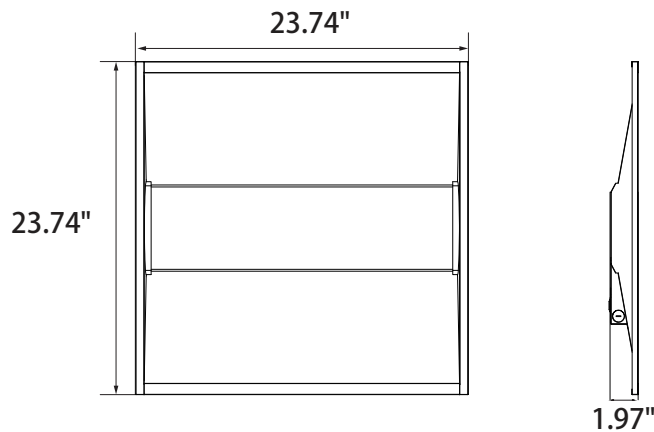

PHOTOMETRY

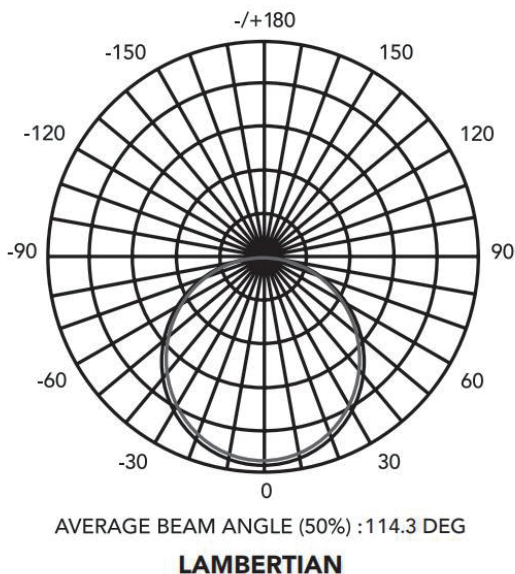

Specifications

Lumens (LM): 2500/3750/4500LM
Efficacy (LPW): 125LM/W
Input Voltage: 120-277V
CRI: > 80
Equivalency (W): 20/30/36W
Operating Temp: -20°C to 35°C
Warranty: 5 Years

WF Harris Lighting, Inc.

Innovative Lighting Designs Since 1970

4015 Airport Ext. Road • Monroe, NC 28110 USA
704.283.7477 (Headquarters) • 800.842.9345 (Toll Free)

E-Mail: customerservice@wfharris.com
www.wfharrislighting.com